



CIB UNIGAS

Accendiamo il domani



**Bruciatori di Gas Low NOx
serie **Tecnopress****

***Low NOx Gas burners
Tecnopress series***

CIB UNIGAS

una posizione rivolta al futuro | *advancing towards the future*



Non tutti i prodotti nascono uguali. Dall'ideazione alla progettazione tecnica, dal collaudo alla commercializzazione, fino all'assistenza post-vendita, il ciclo di vita dei nostri prodotti è uno dei più complessi e completi.

Tutto ha origine nei nostri laboratori di ricerca, dove uno staff di ingegneri entusiasti è libero di sperimentare nuovi materiali e nuove tecnologie idonee a forgiare bruciatori sempre più performanti e puliti. Quando un prototipo è pronto, viene sottoposto a severi collaudi basati su parametri molto più restrittivi di quelli richiesti dal mercato. Solo così nascono famiglie di prodotti estremamente mirate all'uso industriale e civile.

Il metodo dell'eccellenza e della costanza di aggiornamento non impedisce però a CIB UNIGAS di esprimere una formidabile agilità operativa, potendo soddisfare qualsiasi commissione su misura, in tempi e costi sorprendentemente competitivi. I nostri tecnici, specializzati e dedicati all'implementazione di questi prodotti, in collaborazione con il dipartimento di ricerca e sviluppo, hanno fatto tesoro dell'esperienza accumulata negli anni nel campo dei bruciatori Low NO_x standard **Classe 2** (< 120 mg/kWh EN 676) per creare una gamma parallela a basso impatto ambientale **Classe 3** con emissioni inferiori a 80 mg/kWh EN 676, rispettando le indicazioni di CIB UNIGAS sui carichi termici delle caldaie. I nostri bruciatori possono essere equipaggiati con i più moderni sistemi di modulazione automatica di tipo meccanico oppure elettronico, in funzione delle richieste dei mercati ed esigenza dei clienti con possibilità di utilizzare il controllo dell'ossigeno ed inverter.

*Not all products are created equal. Including as it does conception, technical planning, product testing, marketing and after - sales assistance, the life-cycle of our products is extremely complex and complete. Everything begins in our research laboratories, where our team of enthusiastic engineers is free to experiment with new materials and new techniques that can create ever cleaner and more efficient burners. When a prototype is ready, it undergoes testing based on parameters that are much more severe than those required by the market. This is the only way to design our products lines, with their specific cally-targeted industrial and private applications. This method based on excellence and constant updating does not, however, prevent CIB UNIGAS from displaying formidable operation agility, by offering an infinite range of tailor - made solutions that are surprisingly competitive in terms and costs. Working closely with our Research & Development, our technicians specialized and dedicated to the implementation of these products have capitalized on the experience accumulated over the years in the field of standard Low NO_x burners **Class 2** (< 120 mg/kWh EN 676) in order to create a parallel range of Low NO_x **Class 3** (< 80 mg/kWh EN 676) of low environmental impact burners complying with CIB UNIGAS recommendation about boiler thermal load value. Our burners can be equipped with the most modern automatic mechanical or electronic modulation systems according to market and customers requests, with the possibility to use O₂ control and frequency inverter.*

Bruciatori di Gas Low NO_x | Low NO_x GAS burners



classe 2
class 2



classe 3
class 3

I bruciatori a basso NO_x **Classe 2** dispongono di un sistema di miscelazione aria/gas sulla testa tipo **DES** (Dual exit system) che permette una flessibilità di funzionamento ottimale anche nelle condizioni più difficili che si incontrano nelle installazioni.

I bruciatori a basso NO_x **Classe 3** sfruttano una testa di combustione innovativa **LSR** (Low Speed Recirculation) per mezzo della quale si va a ridistribuire il gas secondo pesi differenti e in una zona di depressione. Questo consente ad una parte dei gas combusti di ricircolare internamente.

*Class 2 Low NO_x burners feature an air/gas mixing system called **DES** (Dual Exit System) which allows a flexible and optimal operation even in the most difficult working situations.*

*Class 3 Low NO_x burners feature the innovative combustion head **LSR** (Low Speed Recirculation) through which the gas is distributed according to different weights and in a depression zone. This allows part of the flues gases to recycle internally.*

Configurazione Meccanica | Mechanical Configuration

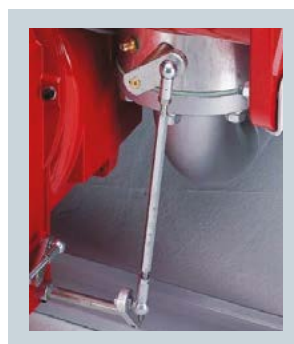
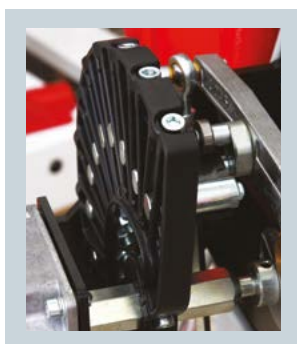

Configurazione Elettronica | Electronic Configuration

Nuovo sistema di regolazione elettronica integrata con la possibilità di installare il controllo di ossigeno, l'inverter e vari protocolli di comunicazione.

New integrated electronic system with the possibility to connect the O₂ probe, frequency inverter, movable head and remote communications.

**SERRANDA ARIA
SERVOMOTOR AIR**



**APPARECCHIATURA E DISPLAY
CONTROL BOX AND DISPLAY**



**VALVOLA A FARFALLA
BUTTERFLY VALVE**



Insonorizzazione | Soundproofing



nRS

noisereductionsystem

Nuovo sistema di insonorizzazione sull'aspirazione aria comburente **NRS** (Noise Reduction System) per diminuire il livello di emissioni sonore.

*New soundproofing system on the air inlet **NRS** (Noise Reduction System) to lower the noise level.*

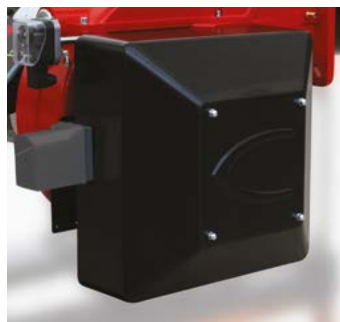

modello 75
model 75

Ventilazione | Ventilation

Il continuo studio e sviluppo nel nostro laboratorio nella divisione ventilazione ha permesso di inserire nei nostri ventilatori un sistema innovativo **HVE** (High ventilation efficiency) che permette di ottenere elevate prestazioni e una sensibile riduzione del consumo energetico.

*Thanks to continuous research and development in the field of ventilation, all our ventilators now feature the **HVE** (High Ventilation Efficiency), enjoying higher performance and significant energy savings.*

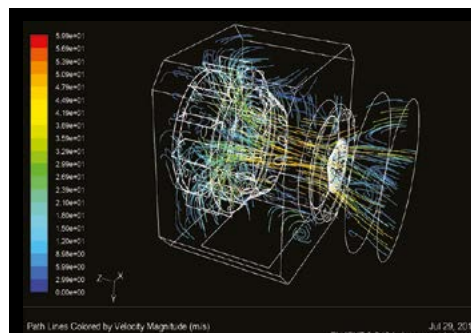
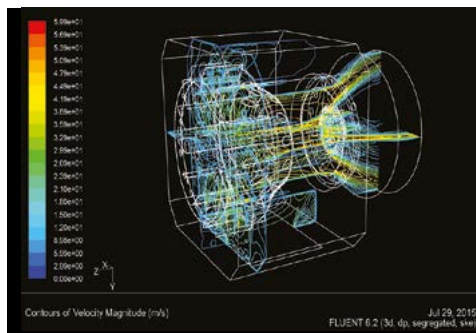

Quadro Elettrico | Electrical panel

L'introduzione del nuovo quadro elettrico ha permesso di ottimizzare in modo razionale tutti gli spazi interni per un accesso più facile ai componenti. Il pannello frontale di nuova concezione permette di visualizzare le differenti funzioni del bruciatore in modo chiaro e visibile.

The introduction of the new electrical panel has optimized all the internal spaces in a rational way, granting an easier access of the components. The highly innovative front panel permits to display the various functions of the burner in a clear and visible way.



modello 75
model 75

LEGENDA SIGLE PER TIPI E MODELLI BURNER IDENTIFICATION



Tipo | Type:

TIPO | TYPE

P..., LX... SERIE | *SERIES TECNOPRESS*
R..., RX... SERIE | *SERIES TECNOPRESS*



Modello | Model:

M - . AB . S . IT . A . 0 . 25 . xx

COMBUSTIBILE | FUEL

M - GAS METANO | *NATURAL GAS*
L - GPL | *LPG*
B - BIOGAS | *BIOGAS*
C - GAS CITTÀ | *TOWN GAS*

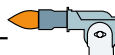

TIPO DI REGOLAZIONE | OPERATION

AB - BISTADIO | *HIGH - LOW FLAME*
PR - PROGESSIVO | *PROGRESSIVE*
MD - MODULANTE | *FULLY MODULATING*

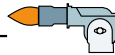

BOCCAGLIO | BLAST TUBE

S - STANDARD L - LUNGO | *LONG*

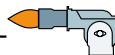

PAESE DI DESTINAZIONE | DESTINATION COUNTRY

IT ITALIA | *ITALY*
... ALTRE DESTINAZIONI A RICHIESTA | *AVAILABLE FOR OTHER COUNTRIES UPON REQUEST*

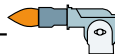

ESECUZIONE BRUCIATORE | BURNER MANUFACTURE

A STANDARD



EQUIPAGGIAMENTO | EQUIPMENT

0 2 VALVOLE GAS | *2 GAS VALVES*
1 2 VALVOLE GAS + CONTROLLO DI TENUTA | *2 GAS VALVES AND LEAKAGE CONTROL*

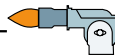

CONNESSIONI RAMPA | GAS CONNECTION

| | | | |
|----|-------|----|------|
| 32 | 1"1/4 | 65 | DN65 |
| 40 | 1"1/2 | 80 | DN80 |
| 50 | 2" | | |

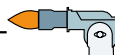

EA Bruciatori di piccola e media potenza a controllo elettronico
Medium-small burners complete with electronic cam
EB Bruciatori di piccola e media potenza a controllo elettronico e con inverter
Medium-small burners complete with electronic cam and inverter
ES Bruciatori di media e grande potenza a controllo elettronico senza controllo O₂ e senza inverter
Medium-large burners complete with electronic cam, without O₂ control, without inverter.
EO Bruciatori di media e grande potenza a controllo elettronico con controllo O₂ e senza inverter
Medium-large burners complete with electronic cam and O₂ control, without inverter

EI Bruciatori di media e grande potenza a controllo elettronico senza controllo O₂ e con inverter
Medium-large burners complete with electronic cam and inverter, without O₂ control
EK Bruciatori di media e grande potenza a controllo elettronico con controllo O₂ e con inverter
Medium-large burners complete with electronic cam, inverter and O₂ control.

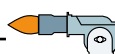

serie tecnopress series

P61 P65 P71 R75A

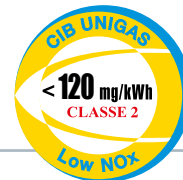

GAS

I bruciatori della serie TECNOPRESS standard **Low NO_x Classe 2 (< 120 mg/kWh)** coprono un campo di applicazione da 160 a 2050 kW e sono impiegati sia su generatori di calore con camera di combustione in depressione sia in pressione. La testa di combustione a campana è in grado di sviluppare fiamme del tipo a diffusione, quindi ad elevato potere di irraggiamento.



*TECNOPRESS burners **Low NO_x Class 2 (< 120 mg/kWh)** cover a wide range of applications from 160 to 2050 kW and are suitable either for heating generators with high back pressure or suction in combustion chamber. The bell-shaped combustion head is able to produce high performance flame.*

CARATTERISTICHE TECNICHE | TECHNICAL DETAILS

| Tipo Type | Modello Model | Potenza kW Power kW | | Alimentazione elettrica Power supply | Motore ventilatore Fan motor kW | Attacchi gas Gas connections Rp | Livello di emissioni sonore Noise level dBA |
|--------------|-------------------|------------------------|-------|---|---------------------------------------|---------------------------------------|---|
| | | min. | max. | | | | |
| P61 | M-.xx.x.IT.A.0.xx | 160 | 800 | 230/400 V 3N ac | 1,1 | 1"1/4 - 1"1/2 - 2" - DN65 | < 80 |
| P65 | M-.xx.x.IT.A.0.xx | 270 | 970 | 230/400 V 3N ac | 1,5 | 1"1/2 - 2" - DN65 | < 80 |
| P71 | M-.xx.x.IT.A.0.xx | 300 | 1.200 | 230/400 V 3N ac | 2,2 | 1"1/2 - 2" - DN65 - DN80 | < 80 |
| P71 | M-.xx.x.IT.A.1.xx | 300 | 1.650 | 230/400 V 3N ac | 2,2 | 1"1/2 - 2" - DN65 - DN80 | < 80 |
| R75A | M-.xx.S.IT.A.1.xx | 320 | 2.050 | 230/400 V 3N ac | 3,0 | 2" - DN65 - DN80 | 75,7 |

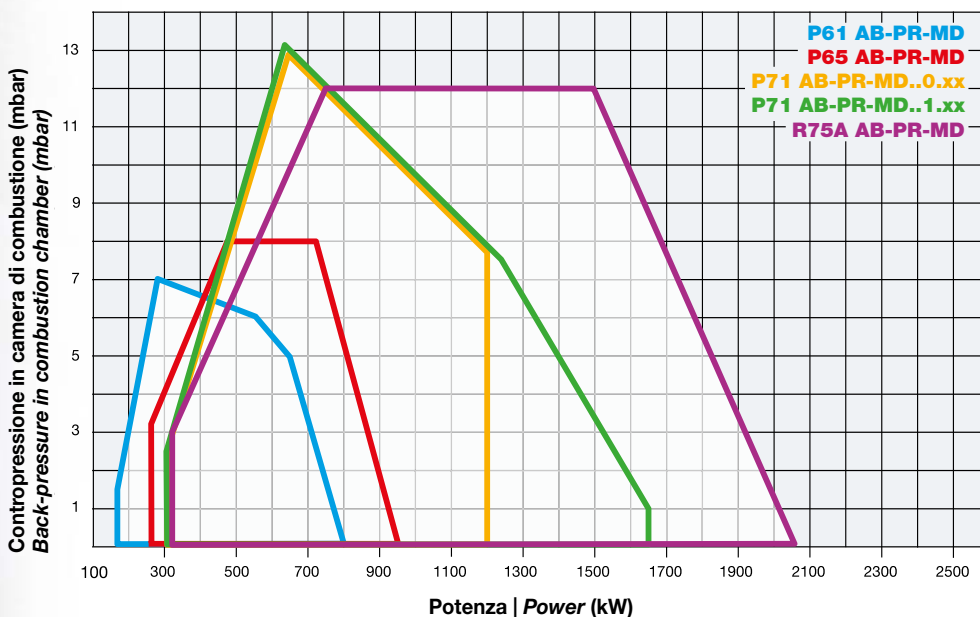



P61 AB-PR-MD

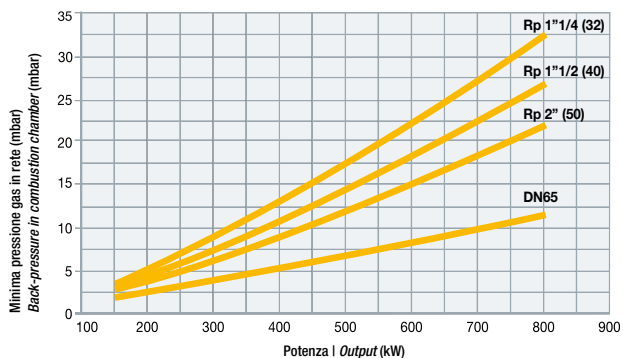

P65 AB-PR-MD

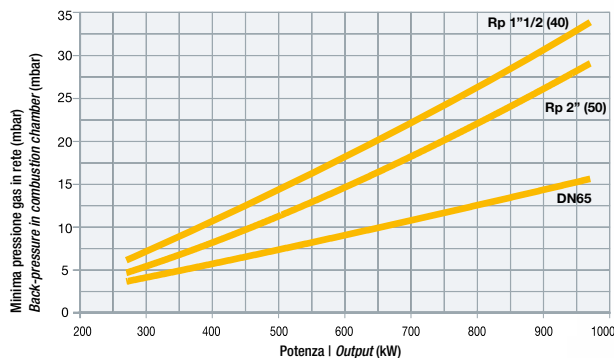

P71 AB-PR-MD..0.xx

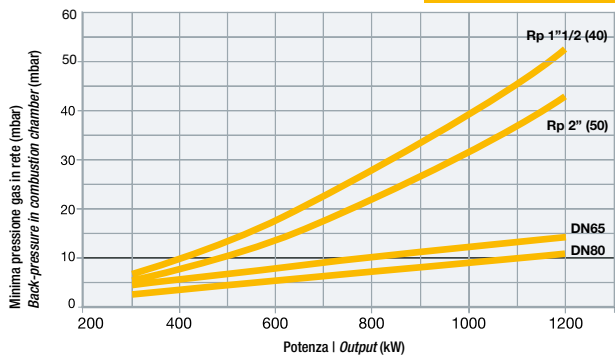

P71 AB-PR-MD..1.xx

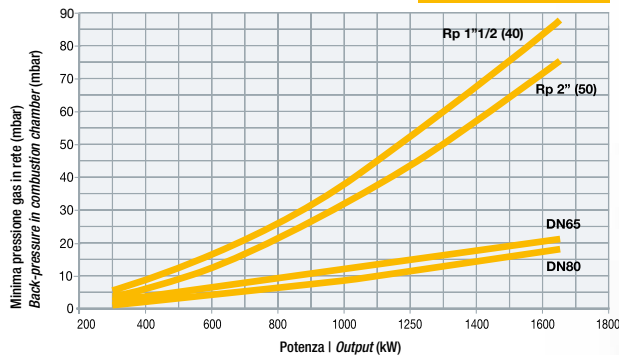

R75A AB-PR-MD

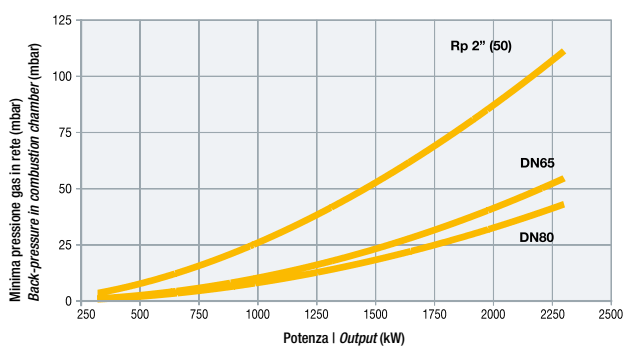

Attenzione: in ascissa è riportato il valore della potenza, in ordinata il corrispondente valore della pressione del gas in rete al netto della pressione in camera di combustione. Per conoscere la pressione minima in ingresso rampa, necessaria per ottenere la potenza richiesta, sommare la pressione in camera di combustione al valore letto in ordinata.

Attention: the graph shows the feeding gas pressure versus the desired power output of the burner. To calculate the minimum required gas pressure, however, it's necessary to add combustion chamber backpressure to the value read on the curve.

serie tecnopress series

P61 P65 P71 R75A

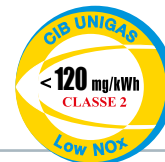

GAS

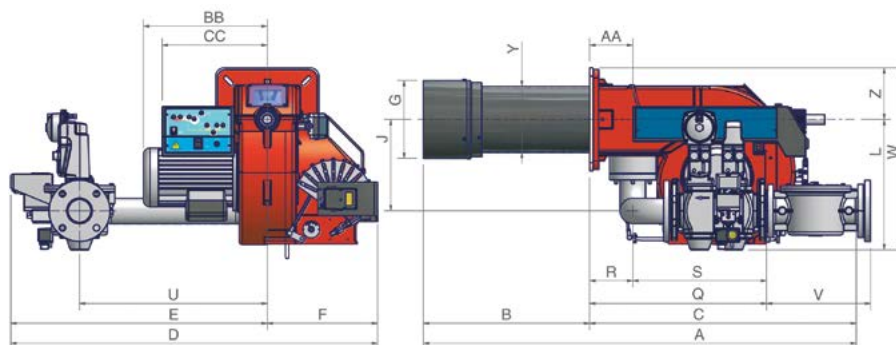

P61

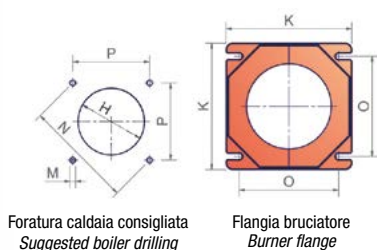

Foratura caldaia consigliata
Suggested boiler drilling

Flangia bruciatore
Burner flange

P65 - P71 - R75A

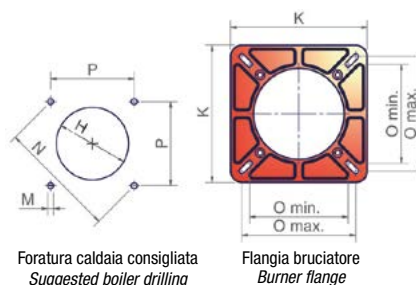

Foratura caldaia consigliata
Suggested boiler drilling

Flangia bruciatore
Burner flange

| Tipo Type | Dimensioni imballo Packaging dimensions (mm) | | | |
|---------------|---|-----|-----|-----|
| | l | p | h | kg |
| P61* | 1200 | 670 | 540 | 60 |
| P65* | 1280 | 850 | 760 | 100 |
| P71* | 1280 | 850 | 760 | 120 |
| R75A** | 1280 | 850 | 760 | 125 |

(*) Valori indicativi (riferiti al modello con rampa gas DN 65)
 (*) Approximate values (regarding model with gas train DN 65)
 (**) Valori indicativi (riferiti al modello con rampa gas DN 80)
 (**) Approximate values (regarding model with gas train DN 80)

| Tipo Type | Modello Model | Dimensioni di ingombro* Overall dimensions* (mm) | | | | | | | | | | | | | | | | | | | | | | | | | | | | |
|--------------|-------------------|--|------|-----|-------|-------|-----|-----|-----|------|-----|-----|-----|-----|-----|-----|-----|-----|-----|-----|-----|-----|-----|-----|-----|-----|-----|-----|-----|-----|
| | | AS | AL | AA | B(S*) | B(L*) | BB | C | CC | D | E | F | G | H | J | K | L | M | N | O | P | Q | R | S | U | V | W | Y | Z | |
| P61 | M-.xx.x.IT.A.0.32 | 1079 | 1169 | 99 | 343 | 433 | 314 | 736 | 298 | 812 | 500 | 312 | 184 | 204 | 210 | 240 | 344 | M10 | 269 | 190 | 190 | 190 | 341 | 112 | 229 | 444 | - | 464 | 162 | 120 |
| P61 | M-.xx.x.IT.A.0.40 | 1079 | 1169 | 99 | 343 | 433 | 314 | 736 | 298 | 812 | 500 | 312 | 184 | 204 | 210 | 240 | 344 | M10 | 269 | 190 | 190 | 190 | 439 | 112 | 327 | 444 | - | 464 | 162 | 120 |
| P61 | M-.xx.x.IT.A.0.50 | 1079 | 1169 | 99 | 343 | 433 | 314 | 736 | 298 | 812 | 500 | 312 | 184 | 204 | 210 | 240 | 344 | M10 | 269 | 190 | 190 | 190 | 447 | 112 | 335 | 444 | - | 464 | 162 | 120 |
| P61 | M-.xx.x.IT.A.0.65 | 1079 | 1169 | 99 | 343 | 433 | 314 | 736 | 298 | 997 | 685 | 312 | 184 | 204 | 250 | 240 | 420 | M10 | 269 | 190 | 190 | 190 | 515 | 112 | 403 | 540 | 313 | 540 | 162 | 120 |
| P65 | M-.xx.x.IT.A.0.40 | 1129 | 1219 | 130 | 326 | 416 | 373 | 803 | 316 | 900 | 568 | 332 | 184 | 218 | 208 | 300 | 376 | M10 | 330 | 216 | 250 | 233 | 457 | 130 | 327 | 519 | - | 531 | 198 | 155 |
| P65 | M-.xx.x.IT.A.0.50 | 1129 | 1219 | 130 | 326 | 416 | 373 | 803 | 316 | 900 | 568 | 332 | 184 | 218 | 208 | 300 | 376 | M10 | 330 | 216 | 250 | 233 | 465 | 130 | 335 | 519 | - | 531 | 198 | 155 |
| P65 | M-.xx.x.IT.A.0.65 | 1129 | 1219 | 130 | 326 | 416 | 373 | 803 | 316 | 998 | 666 | 332 | 184 | 218 | 275 | 300 | 393 | M10 | 330 | 216 | 250 | 233 | 533 | 130 | 403 | 565 | 313 | 548 | 198 | 155 |
| P71 | M-.xx.x.IT.A.1.40 | 1188 | 1298 | 130 | 385 | 495 | 373 | 803 | 316 | 1026 | 694 | 332 | 234 | 264 | 208 | 300 | 376 | M10 | 330 | 216 | 250 | 233 | 457 | 130 | 327 | 519 | - | 531 | 198 | 155 |
| P71 | M-.xx.x.IT.A.1.50 | 1188 | 1298 | 130 | 385 | 495 | 373 | 803 | 316 | 1026 | 694 | 332 | 234 | 264 | 208 | 300 | 376 | M10 | 330 | 216 | 250 | 233 | 465 | 130 | 335 | 519 | - | 531 | 198 | 155 |
| P71 | M-.xx.x.IT.A.1.65 | 1188 | 1298 | 130 | 385 | 495 | 373 | 803 | 316 | 1104 | 772 | 332 | 234 | 264 | 275 | 300 | 393 | M10 | 330 | 216 | 250 | 233 | 533 | 130 | 403 | 565 | 313 | 548 | 198 | 155 |
| P71 | M-.xx.x.IT.A.1.80 | 1188 | 1298 | 130 | 385 | 495 | 373 | 803 | 316 | 1106 | 774 | 332 | 234 | 264 | 275 | 300 | 407 | M10 | 330 | 216 | 250 | 233 | 574 | 130 | 444 | 565 | 344 | 562 | 198 | 155 |
| R75A | M-.xx.S.IT.A.1.50 | 1429 | - | 138 | 503 | - | 374 | 926 | 330 | 1062 | 700 | 362 | 254 | 270 | 229 | 300 | 420 | M10 | 330 | 216 | 250 | 233 | 465 | 130 | 335 | 525 | - | 575 | 210 | 155 |
| R75A | M-.xx.S.IT.A.1.65 | 1429 | - | 138 | 503 | - | 374 | 926 | 330 | 1139 | 777 | 362 | 254 | 270 | 296 | 300 | 420 | M10 | 330 | 216 | 250 | 233 | 533 | 130 | 403 | 570 | 313 | 575 | 210 | 155 |
| R75A | M-.xx.S.IT.A.1.80 | 1429 | - | 138 | 503 | - | 374 | 926 | 330 | 1141 | 779 | 362 | 254 | 270 | 296 | 300 | 428 | M10 | 330 | 216 | 250 | 233 | 574 | 130 | 444 | 570 | 344 | 583 | 210 | 155 |

(*) Valori indicativi | Approximate values



La serie TECNOPRESS **Low NO_x Classe 3** (< 80 mg/kWh) rappresenta la gamma di media potenza della produzione dedicata ai bruciatori a basse emissioni di NO_x. Risultato della lunga esperienza di CIB UNIGAS nel campo delle applicazioni fino a 1800 kW, questa serie si caratterizza per la semplicità di utilizzo in fase di regolazione, di tipo meccanico o elettronico, e per l'estrema semplicità in sede di assistenza, grazie al posizionamento facilmente accessibile di tutti i componenti.

*The TECNOPRESS series **Low NO_x Class 3** (<80 mg/kWh) represent the average output range. This series is the result of the CIB UNIGAS great experience in projects involving outputs up to 1800 kW, and is characterized for simple mechanical or electronic adjusting procedure and simple maintenance, thanks to the optimized components.*



CARATTERISTICHE TECNICHE | TECHNICAL DETAILS

| Tipo Type | Modello Model | Potenza kW Power kW | | Alimentazione elettrica Power supply | Motore ventilatore Fan motor kW | Attacchi gas Gas connections Rp | Livello di emissioni sonore Noise level dBA |
|--------------|-------------------|------------------------|-------|---|---------------------------------------|---------------------------------------|---|
| | | min. | max. | | | | |
| LX60 | M-.xx.x.IT.A.0.xx | 165 | 720 | 230/400 V 3N ac | 1,1 | 1"1/2 - 2" - DN65 | < 80 |
| LX72 | M-.xx.x.IT.A.0.xx | 241 | 1.040 | 230/400 V 3N ac | 2,2 | 2" - DN65 - 80 | < 80 |
| RX75R | M-.xx.x.IT.A.0.xx | 270 | 1.200 | 230/400 V 3N ac | 2,2 | 1"1/2 - 2" - DN65 | 75,7 |
| RX75 | M-.xx.x.IT.A.0.xx | 300 | 1.800 | 230/400 V 3N ac | 3,0 | 1"1/2 - 2" - DN65 - 80 | 75,7 |

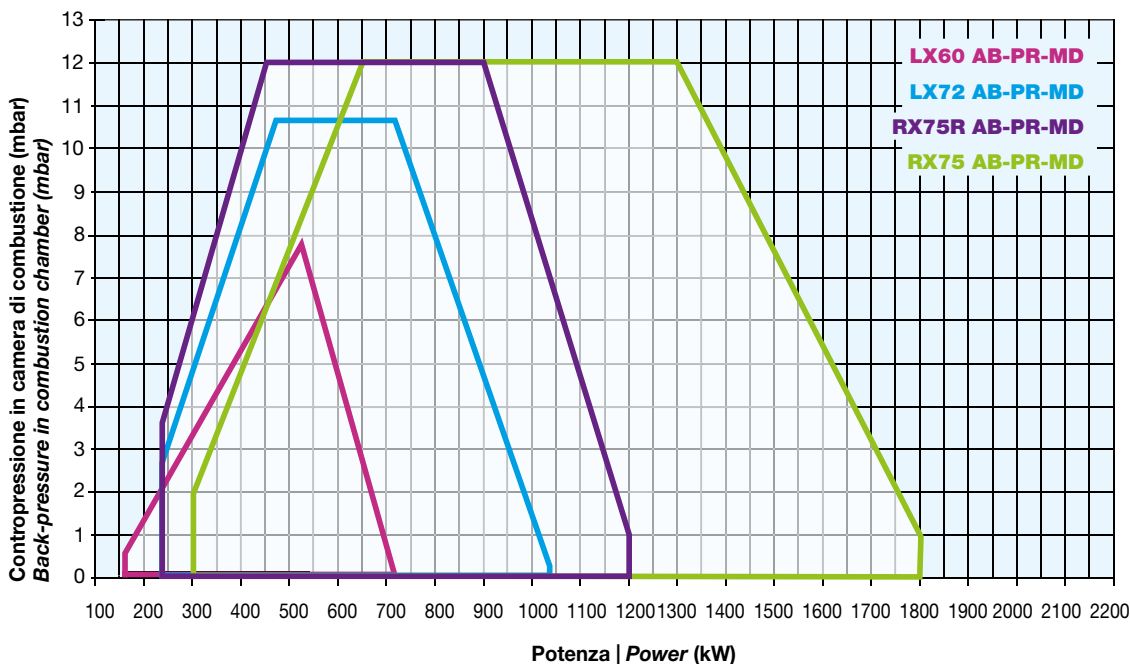

serie tecnopress series

LX60 LX72 RX75R RX75



GAS

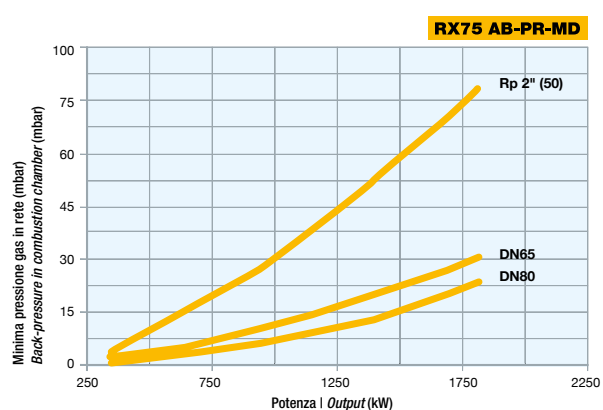
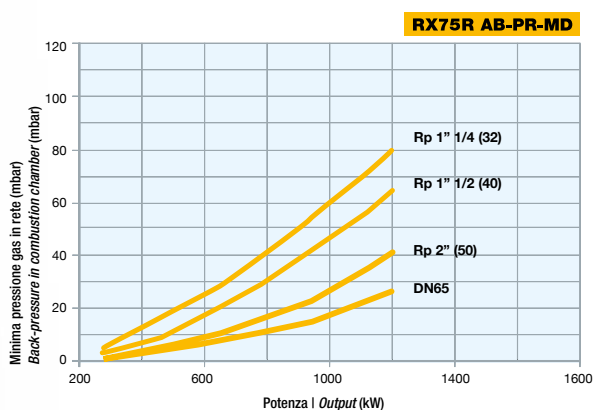
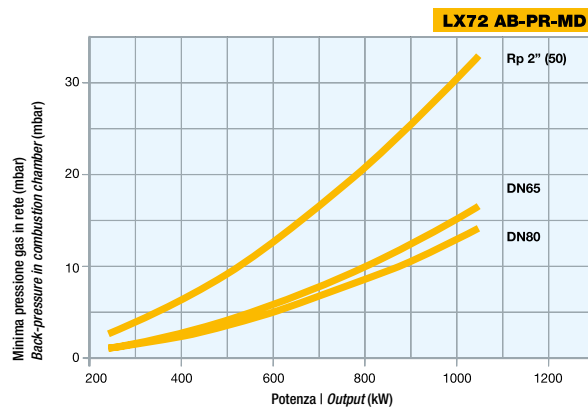
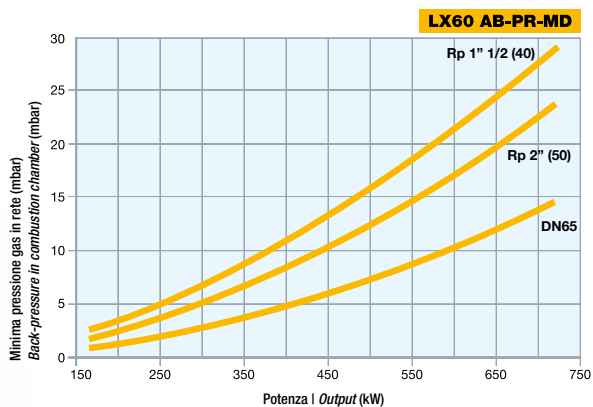

Attenzione: in ascissa è riportato il valore della potenza, in ordinata il corrispondente valore della pressione del gas in rete al netto della pressione in camera di combustione. Per conoscere la pressione minima in ingresso rampa, necessaria per ottenere la potenza richiesta, sommare la pressione in camera di combustione al valore letto in ordinata.

Attention: the graph shows the feeding gas pressure versus the desired power output of the burner. To calculate the minimum required gas pressure, however, it's necessary to add combustion chamber backpressure to the value read on the curve.

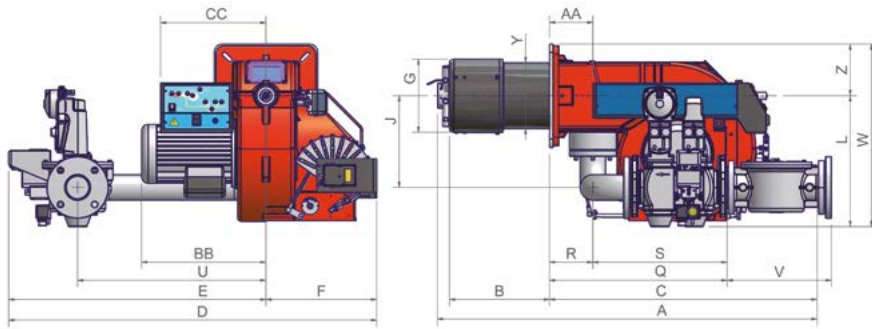

| Tipo Type | Dimensioni imballo* Packaging dimensions* (mm) | | | |
|--------------|---|-----|-----|-----|
| | l | p | h | kg |
| LX60 | 1200 | 670 | 540 | 60 |
| LX72 | 1280 | 850 | 760 | 110 |
| RX75R | 1280 | 850 | 760 | 125 |
| RX75 | 1280 | 850 | 760 | 125 |

LX60

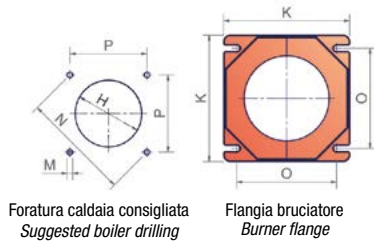

LX72 - RX75R - RX75

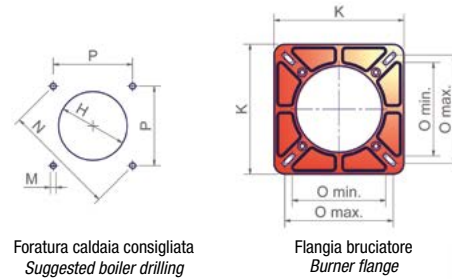

| Tipo Type | Modello Model | Dimensioni di ingombro* Overall dimensions* (mm) | | | | | | | | | | | | | | | | | | | | | | | | | | | | | | | | | | | | | | | |
|--------------|-------------------|--|------|-----|-----|-----|-----|-----|-----|------|-----|-----|-----|-----|-----|-----|-----|-----|-----|-----------|-----|-----|-----|-----|-----|-----|-----|-----|-----|-----|--|--|--|--|--|--|--|--|--|--|--|
| | | AS | AL | AA | BS | BL | BB | C | CC | D | E | F | G | H | J | K | L | M | N | O | P | Q | R | S | U | V | W | Y | Z | | | | | | | | | | | | |
| | | | | | | | | | | | | | | | | | | | | min. max. | | | | | | | | | | | | | | | | | | | | | |
| LX60 | M-.xx.x.xx.A.0.40 | 1026 | 1206 | 99 | 252 | 432 | 314 | 736 | 298 | 812 | 500 | 312 | 185 | 204 | 210 | 240 | 344 | M10 | 269 | 190 | 190 | 190 | 439 | 112 | 327 | 444 | - | 464 | 162 | 120 | | | | | | | | | | | |
| LX60 | M-.xx.x.xx.A.0.50 | 1026 | 1206 | 99 | 252 | 432 | 314 | 736 | 298 | 812 | 500 | 312 | 185 | 204 | 210 | 240 | 344 | M10 | 269 | 190 | 190 | 190 | 447 | 112 | 335 | 444 | - | 464 | 162 | 120 | | | | | | | | | | | |
| LX60 | M-.xx.x.xx.A.0.65 | 1026 | 1206 | 99 | 252 | 432 | 314 | 736 | 298 | 997 | 685 | 312 | 185 | 204 | 250 | 240 | 420 | M10 | 269 | 190 | 190 | 190 | 515 | 112 | 403 | 540 | 313 | 540 | 162 | 120 | | | | | | | | | | | |
| LX72 | M-.xx.x.xx.A.1.50 | 1139 | 1224 | 130 | 300 | 385 | 373 | 803 | 316 | 1104 | 772 | 332 | 219 | 249 | 275 | 300 | 393 | M10 | 330 | 216 | 250 | 233 | 533 | 130 | 403 | 565 | 313 | 548 | 198 | 155 | | | | | | | | | | | |
| LX72 | M-.xx.x.xx.A.1.65 | 1139 | 1224 | 130 | 300 | 385 | 373 | 803 | 316 | 1106 | 774 | 332 | 219 | 249 | 275 | 300 | 407 | M10 | 330 | 216 | 250 | 233 | 574 | 130 | 444 | 565 | 344 | 562 | 198 | 155 | | | | | | | | | | | |
| LX72 | M-.xx.x.xx.A.1.80 | 1139 | 1224 | 130 | 300 | 385 | 373 | 803 | 316 | 1106 | 774 | 332 | 219 | 249 | 275 | 300 | 407 | M10 | 330 | 216 | 250 | 233 | 574 | 130 | 444 | 565 | 344 | 562 | 198 | 155 | | | | | | | | | | | |
| RX75R | M-.xx.S.IT.A.1.40 | 1338 | 1463 | 138 | 378 | 503 | 374 | 926 | 330 | 1062 | 700 | 362 | 250 | 280 | 235 | 300 | 420 | M10 | 330 | 216 | 250 | 233 | 454 | 127 | 327 | 570 | 313 | 603 | 210 | 155 | | | | | | | | | | | |
| RX75R | M-.xx.S.IT.A.1.50 | 1338 | 1463 | 138 | 378 | 503 | 374 | 926 | 330 | 1062 | 700 | 362 | 250 | 280 | 235 | 300 | 420 | M10 | 330 | 216 | 250 | 233 | 465 | 127 | 338 | 525 | - | 603 | 210 | 155 | | | | | | | | | | | |
| RX75R | M-.xx.S.IT.A.1.65 | 1338 | 1463 | 138 | 378 | 503 | 374 | 926 | 330 | 1139 | 777 | 362 | 250 | 280 | 296 | 300 | 420 | M10 | 330 | 216 | 250 | 233 | 530 | 127 | 403 | 570 | 313 | 603 | 210 | 155 | | | | | | | | | | | |
| RX75 | M-.xx.S.IT.A.1.40 | 1338 | 1463 | 138 | 358 | 483 | 374 | 926 | 330 | 1062 | 700 | 362 | 270 | 290 | 235 | 330 | 420 | M10 | 330 | - | 250 | 233 | 454 | 127 | 327 | 525 | - | 603 | 210 | 155 | | | | | | | | | | | |
| RX75 | M-.xx.S.IT.A.1.50 | 1338 | 1463 | 138 | 358 | 483 | 374 | 926 | 330 | 1062 | 700 | 362 | 270 | 290 | 235 | 330 | 420 | M10 | 330 | - | 250 | 233 | 465 | 127 | 338 | 525 | - | 603 | 210 | 155 | | | | | | | | | | | |
| RX75 | M-.xx.S.IT.A.1.65 | 1338 | 1463 | 138 | 358 | 483 | 374 | 926 | 330 | 1139 | 777 | 362 | 270 | 290 | 296 | 330 | 420 | M10 | 330 | - | 250 | 233 | 530 | 127 | 403 | 570 | 313 | 603 | 210 | 155 | | | | | | | | | | | |
| RX75 | M-.xx.S.IT.A.1.80 | 1338 | 1463 | 138 | 358 | 483 | 374 | 926 | 330 | 1141 | 779 | 362 | 270 | 290 | 296 | 330 | 428 | M10 | 330 | - | 250 | 233 | 571 | 127 | 444 | 570 | 344 | 615 | 210 | 155 | | | | | | | | | | | |

(*) Valori indicativi | Approximate values

CONTROLLO ELETTRONICO CON LMV 2... LMV 3... per bruciatori di bassa, media e alta potenza



| Modello Model | Serie Series | Combustibili Fuel | LMV20 | LMV37 | |
|------------------|-----------------|---------------------------------|-------|-------|--|
| EA | TECNOPRESS | gas (fino a <i>up to 2"</i>) | ● | | |
| EA | TECNOPRESS | gas (da <i>from DN65</i>) | ● | | |
| EB | TECNOPRESS | gas (fino a <i>up to 2"</i>) | | ● | |
| EB | TECNOPRESS | gas (da <i>from DN65</i>) | | ● | |

EA Bruciatori a controllo elettronico
Medium-small burners complete with electronic cam

EB Bruciatori a controllo elettronico con inverter
Medium-small burners complete with electronic cam and inverter

**WITH LMV 2... LMV 3... MICROPROCESSOR
for low and medium power burners**



|  |  |  |  |  |
|---|---|---|---|---|
| AZL 23 | SQN14 gas | SQM33 aria air | SQM33 gas | INVERTER |
| • | • | • | | |
| • | | • | • | |
| • | | • | • | • |
| • | | • | • | • |

CONTROLLO ELETTRONICO CON LMV 5... per bruciatori di media e alta potenza



| Modello <i>Model</i> | Serie <i>Series</i> | Combustibili <i>Fuel</i> | LMV 51.100 | LMV 51.300 | LMV52.200 |
|-------------------------|------------------------|-----------------------------|------------|------------|-----------|
| ES | TECNOPRESS | gas | ● | | |
| EO | TECNOPRESS | gas | | | ● |
| EI | TECNOPRESS | gas | | ● | |
| EK | TECNOPRESS | gas | | | ● |

ES Bruciatori di media e grande potenza a controllo elettronico senza controllo O₂ e senza Inverter
Medium-large burners complete with electronic cam, without O₂ control, without Inverter





EO Bruciatori di media e grande potenza a controllo elettronico con controllo O₂ e senza Inverter
Medium-large burners complete with electronic cam and O₂ control, without Inverter

EI Bruciatori di media e grande potenza a controllo elettronico senza controllo O₂ e con Inverter
Medium-large burners complete with electronic cam and Inverter, without O₂ control

EK Bruciatori di media e grande potenza a controllo elettronico con controllo O₂ e con Inverter
Medium-large burners complete

WITH LMV 5... MICROPROCESSOR
for medium and high output burners



|  |  |  |  |  |
|---|---|---|--|---|
| AZL 5x | SQM4x aria air | SQM4x gas | SONDA O ₂ O ₂ PROBE | INVERTER |
| • | • | • | | |
| • | • | • | • | |
| • | • | • | | • |
| • | • | • | • | • |



M02986P Rel. 0 03/2016

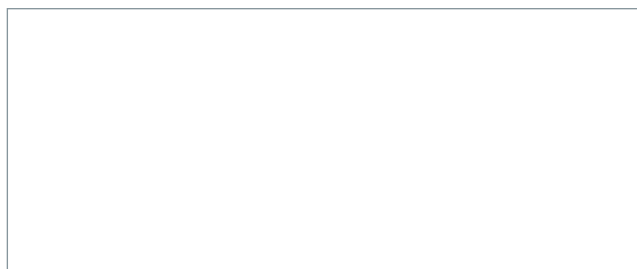

CIB UNIGAS
Accendiamo il domani

C.I.B. UNIGAS S.p.A.

Via L. Galvani, 9 - 35011 CAMPODARSEGO (PD) - Italy
Tel. +39 049 9200944 - Fax +39 049 9200945 - 9201269

Fax Export +39 049 9202105

cibunigas@cibunigas.it - www.cibunigas.it



I dati riportati su questo catalogo sono da ritenersi indicativi e non impegnativi; Cib Unigas si riserva la facoltà di apportare modifiche senza obbligo di preavviso.
Specifications and data subject to change without notice. Errors and omissions excepted.